



COMPANY PROFILE

نابوليا
Nabolia

OVER 
25 YEARS 
OF EXPERIENCE 



WWW.NABOLIA.COM

About “ NABOLIA

The idea of establishing Nabolia company began with the aim of providing a large factory with great potential to serve as an integrated factory for everyone working in the furniture sector in various activities.

Since the beginning of the establishment in 1998 the company has gained the trust of different customers from manufacturers, designers, importers and so on. The company relies in its dealings with customers on the principle of "integrity." We value our customers and seek only to achieve their interests.

Our goal is not to be a competitor for our clients but our goal is to expand the scope of our clients work and provide the full manufacturing and executive cycle, starting with the provision of materials and accessories and their formation or implementation of design and installation and so on.



Why NABOLIA

Success

Nabolia is your partner to success

Faster Delivery

Faster delivery of your projects

Reliable Support

Reliable and dependable support

Post Forming Services

POST FORMING

Primary Services

Post forming services: Nabolia can provide post-forming components that are tailor, cut to-size, profiled, pressed, post-formed, and edge-banded to customers.



Caracas

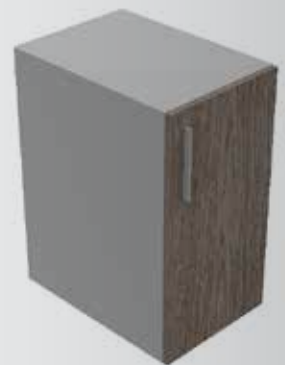
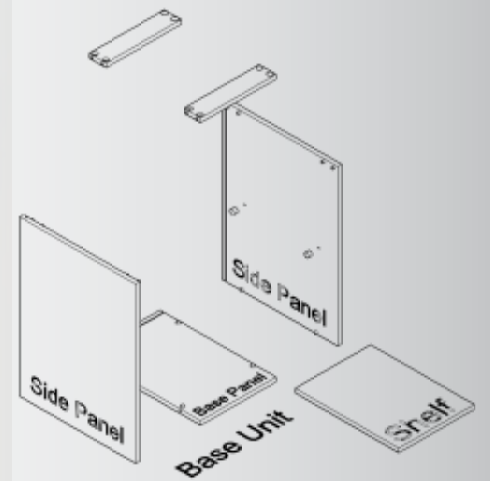
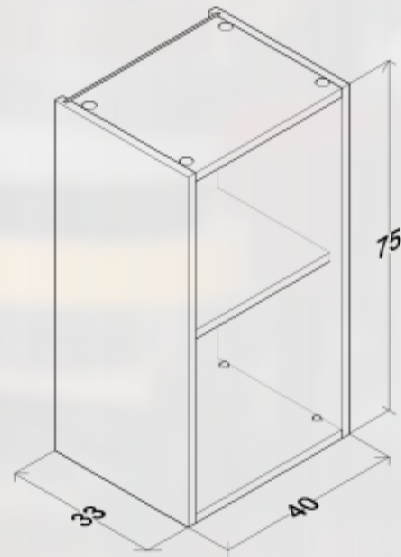
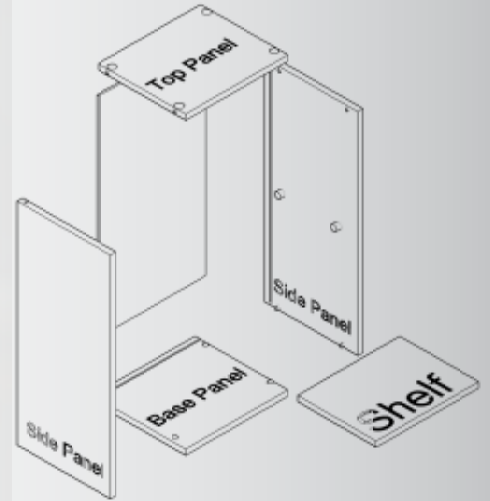
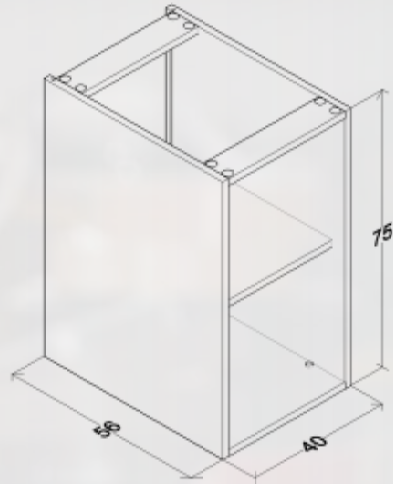

Post Forming Profiles

Naboilia offers various postforming profiles to suit different applications.



Profile 1

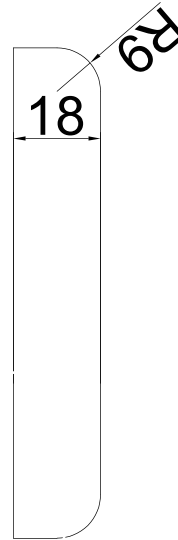

Profile 3

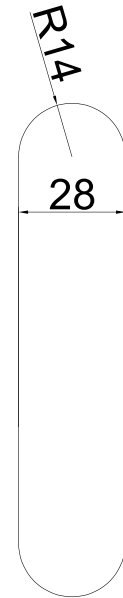

Profile 11

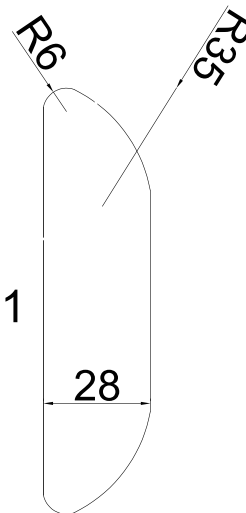

Profile 5

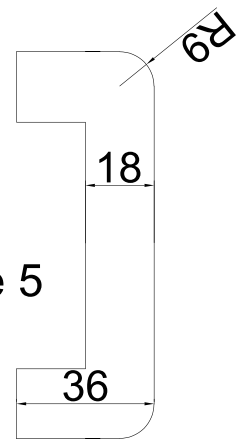

Doors



نابوليا
Nabolia

HPL



نابوليا
Nabolia

Designs





10172



10189



10510



10573



10679



10680



10843



10880



11682



14132



14140



14142



14613



14620



14621



14636



14641



14649



14687



14688



21027



21065



21066

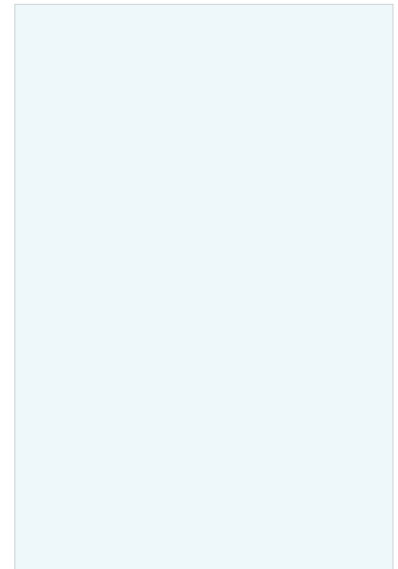

21081

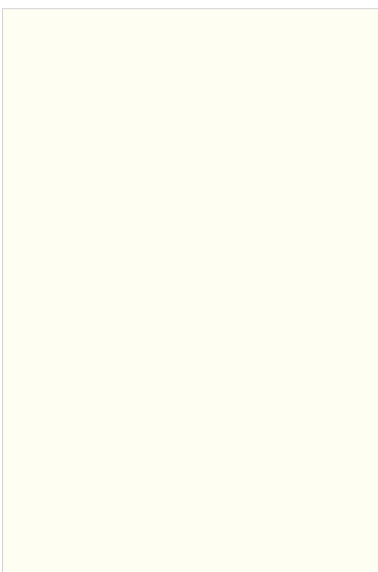

21091



44704



49916



49931



49931



49947

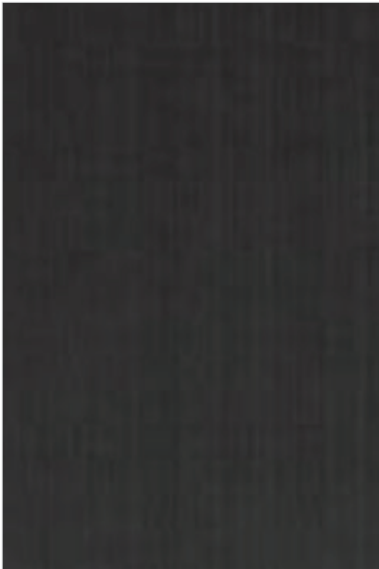

49951



10672

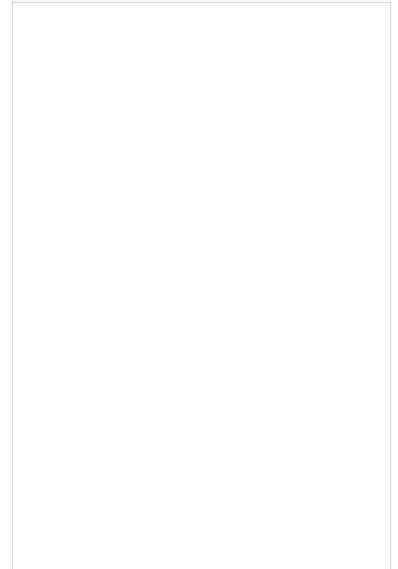

21481



40265



40477

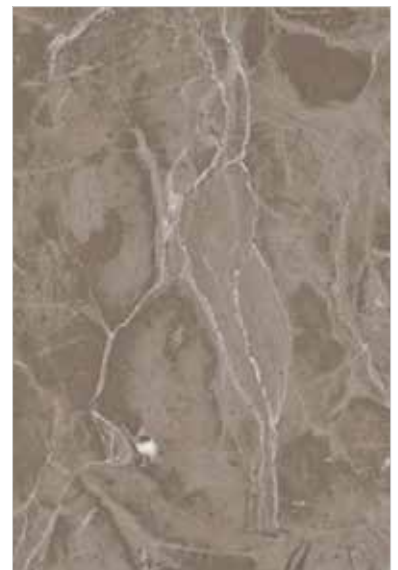

40216



40261



40261



40268



40268





10311



10346



10351

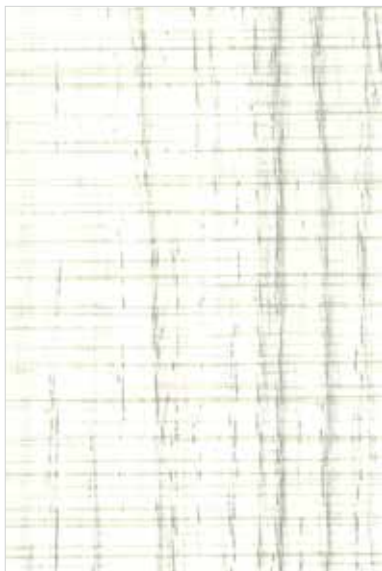

10352



10368



10369



10425



10438

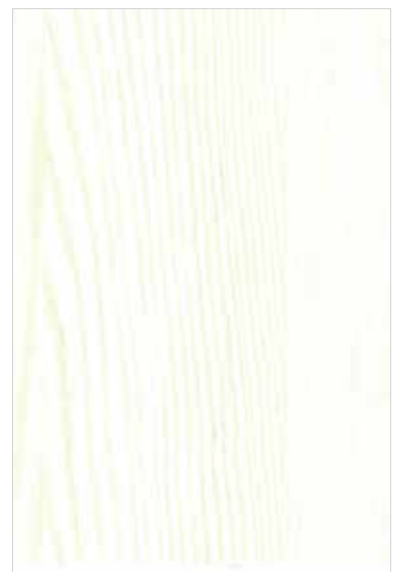

10438



10453

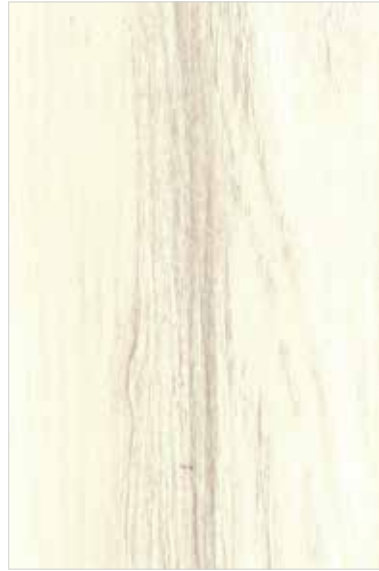

10453



10454



10454



10474



10478



10481



10490



10491



10493



10493



10612



21424

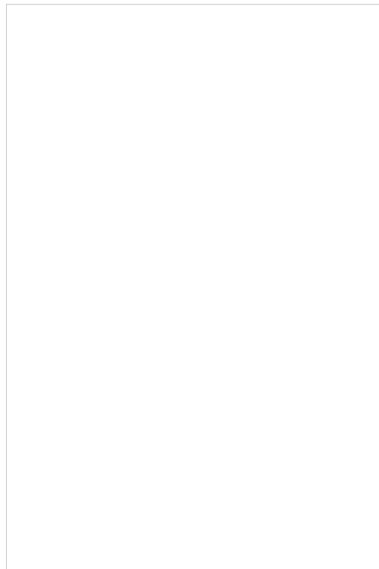

22291

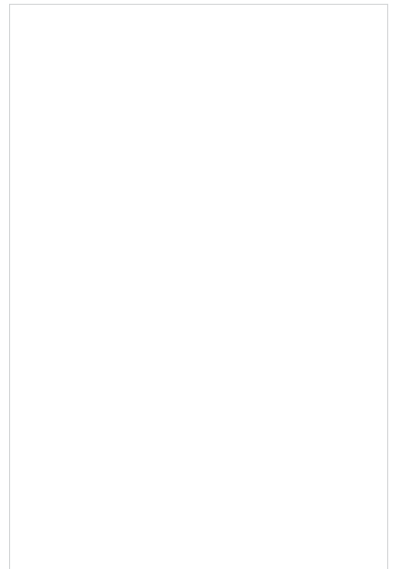

10347



10348



10349



10368



10388



10419



10429



10455



10457



10479



10612



10638



21028



21066

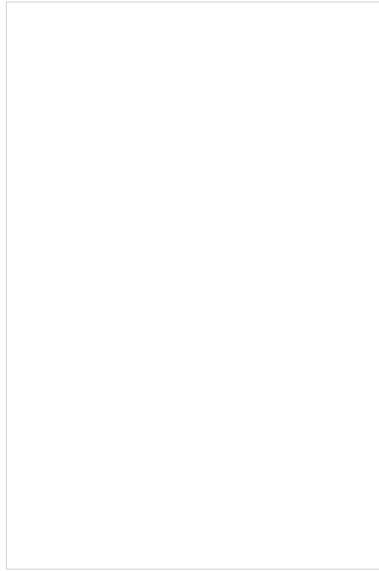

21089



21299



21433

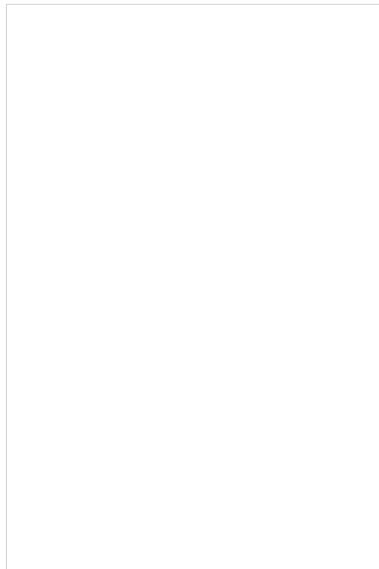

22291



23087

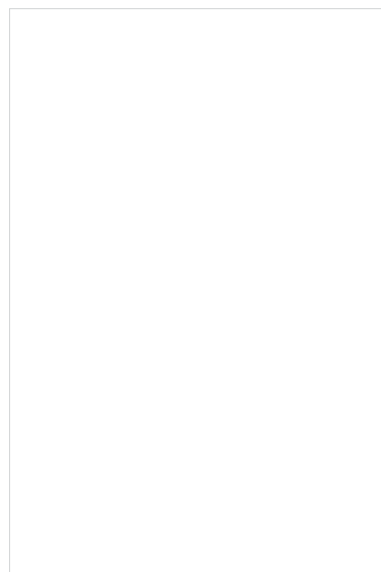

23381



نابوليا Nabolia



Office: 2 Bahgat Aly st., El Masry towers,
Tower C, Zamalek 11211,Cairo, Egypt



Factory: Industrial Zone, Inshas Road -
Off Cairo Belbeis Desert Road



info@nabolia.com



+2 010 25531543



www.nabolia.com



+2 055 2641996